

Manifold Installation Controller MIC-180

Installation and Operation Instructions

For Use With Rheem-Ruud and Paloma Commercial Tankless Water Heaters

Table of Contents

Safety Information	1-2
Manifold Installation Control System	3
Installing the Manifold Controller	4
Mounting the Manifold Controller	4
Electrical Connections	4-5
Connecting Communication Cable to the Water Heaters ..	6-7
Connecting and Wiring the Manifold Controller	7-8
Setting Hot Water Temperature	9
Typical Installation of Extended Manifold Controller	10-11
Trial Operation of Manifold Installation Controller	12
If You Need Service	12

SAFETY PRECAUTIONS

- Read these instructions and the water heater instruction manual entirely before installing or operating the manifold controller and the water heater.
- Use this manifold controller only for its intended purpose as described in these instructions.
- Be sure your water heater and the manifold controller are properly installed in accordance with local codes and the provided installation instructions.
- Do not attempt to repair or replace any parts. All servicing should be referred to a qualified technician.
- Read and follow all instructions. Save this instruction for future reference.

IMPORTANT SAFETY INFORMATION

READ ALL INSTRUCTIONS BEFORE USING

WARNING:

For your safety, the information in these instructions and the instructions provided with the water heater must be followed to minimize the risk of fire or explosion, electric shock, or to prevent property damage, personal injury, or loss of life.

Improper adjustment, alteration, service or maintenance can cause property damage, personal injury or death. Only qualified service personnel should install or make adjustments.

DANGER:

WATER TEMPERATURE SETTING

Safety and energy conservation are factors to be considered when selecting the water temperature setting of a water heater. Water temperatures above 125°F (52°C) can cause severe burns or death from scalding. Be sure to read and follow the warning outlined in the label pictured below.

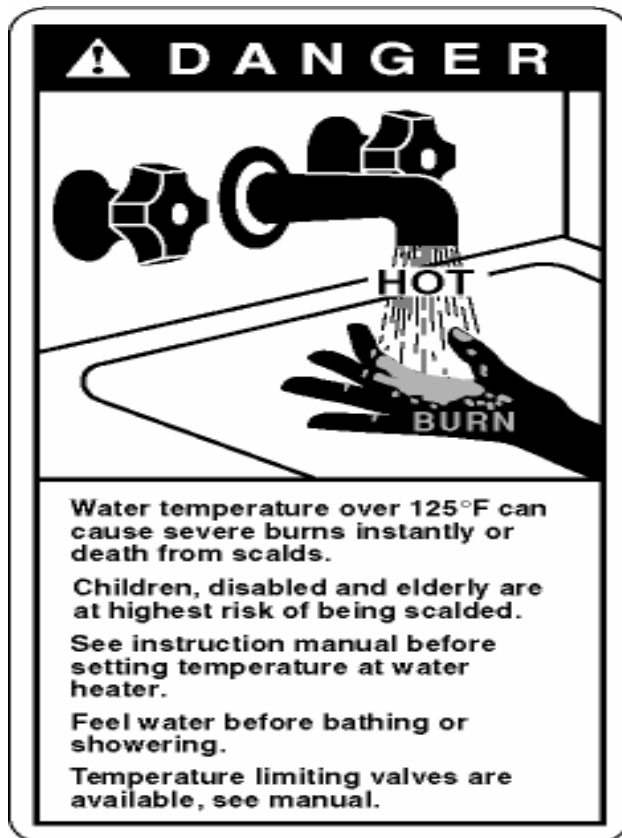

TIME/TEMPERATURE REALTIONSHIP IN SCALDS

Temperature	Time to Produce Serious Burn
120°F (49°C)	More than 5 minutes
125°F (52°C)	1½ to 2 minutes
130°F (54°C)	About 30 seconds
135°F (57°C)	About 10 seconds
140°F (60°C)	Less than 5 seconds
145°F (63°C)	Less than 3 seconds
150°F (66°C)	About 1½ seconds
155°F (68°C)	About 1 second

Danger: Hotter water increases the risk of hot water scalds.

The time/temperature relationship table shown above may be used as a guide in determining the proper water temperature for your home or any other application.

A thermostatically controlled mixing valve for reducing point of use water temperature is recommended to reduce the risk of scald injury. Contact a licensed plumber or local plumbing authority for further information.

DANGER: Households with small children, disabled, or elderly persons may require a 120°F (49°C) or lower temperature setting to prevent contact with “Hot” water.

1. Manifold Installation Control System (MIC-180)

The manifold installation control system (MIC-180) consists of a main communication PCB for manifolding two (2) to six (6) water heaters, mounting screws, manifold box, power supply cord, and connector for optional hardwiring.

Manifold controller (MIC-180) provides control of two (2) to six (6) water heaters when properly installed and connected with communication cables (sold separately) to any Rheem-Ruud or Paloma commercial Tankless Water Heaters. To control additional water heaters (7 to 20 water heaters), it is necessary to purchase an extended communication PCB (MICS-180) separately and install in the control system. See section 6, "Typical Installation of Extended Manifold Controller" on page 10 for instructions on installing extended communications PCB.

This instruction sheet outlines the configuration and installation for manifolding two (2) to twenty (20) water heaters.

NOTICE:

No other manufacturer's controls are suitable with Rheem-Ruud or Paloma Commercial Tankless Water Heaters. Do not attempt to disassemble any of the controls or components.

1-1. Optional Parts

- Extended communication PCB (MICS-180) for manifold control of seven (7) to twenty (20) water heaters
- Communication cable (available in 16 ft (4.87 m), 32 ft (9.75 m), and 65 ft (19.81 m) length)

Components	Number of Water Heaters	
	2 ~ 6 Units	7 ~ 20 Units
Manifold controller (Basic Unit) - MIC-180	1	1
Extended communication PCB - MICS-180 ⁺	Not applicable	1
Communication cable (16 feet) - MIC-K-16*	2 ~ 6	7 ~ 20
Communication cable (32 feet) - MIC-K-32*	2 ~ 6	7 ~ 20
Communication cable (65 feet) - MIC-K-65*	2 ~ 6	7 ~ 20

⁺ Extended communication PCB (MICS-180) includes one relay cable and one screw.

* Communication cables include two clamps and two screws.

1-2. Typical Manifold Installation

[UP to 6 Units]

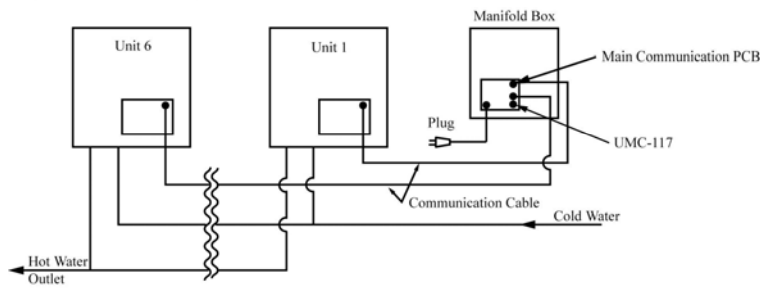

NOTICE:

- Piping must be "parallel" piping only.
- Water pressure of 40 psi to each water heater is recommended for proper operation.

[UP to 20 Units]

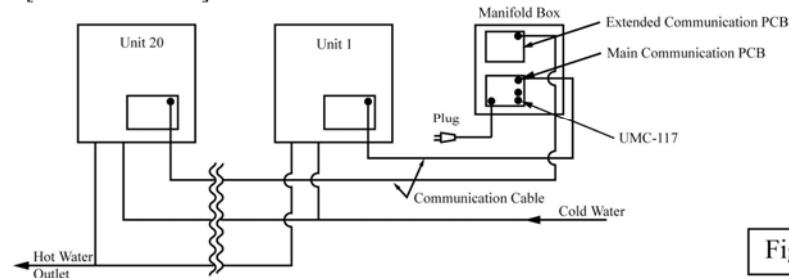

Figure 1

See figure 1 for typical installations of a manifold controller and extended communication PCB with multiple water heaters. An extended communication PCB is required for installation of more than six (6) water heaters. The extended communication PCB and the communication cables are sold separately.

NOTICE:

Install the water heater, water piping, and gas piping per installation instructions provided with the water heaters. A shutoff valve should be installed at the inlet water pipe, outlet water pipe and gas inlet line of each water heater to facilitate easy service.

2. Installing the Manifold Controller

NOTICE: Follow instructions provided with the water heater for installing the water heater and main remote control. The main remote control is provided with the water heater.

Location

The manifold controller (MIC-180) can be installed indoors or outdoors. The main remote control (UMC-117) must be installed indoors and per instructions provided with the water heater.

2-1. Mounting the Manifold Controller

Make sure the location of the manifold controller allows easy access for service and operation.

Wall studs should be utilized when mounting the manifold controller to the wall. Alternately, a suitable piece of wood may be placed inside or outside of the wall to span the distance between the wall studs. Fasten the water heater mounting brackets to the wood. In case of dry wall or concrete wall use dry wall anchors or lag bolts.

Install a wood screw for the upper bracket with a clearance of 1/8" (3 mm) between the wall and the screw head. Hang the center of the upper bracket on the screw. Using a wood screw and washer, affix the lower bracket to the wall (Left and right). Repeat to affix the top bracket. See figure 2 shown below for typical mounting of the manifold controller.

The manifold controller requires 120VAC/60Hz. Have a receptacle with the ground terminal near the manifold controller. The length of the power supply cord is 10 feet (3.05 m). If local codes require, or if installed outdoors, the manifold controller should be hard wired.

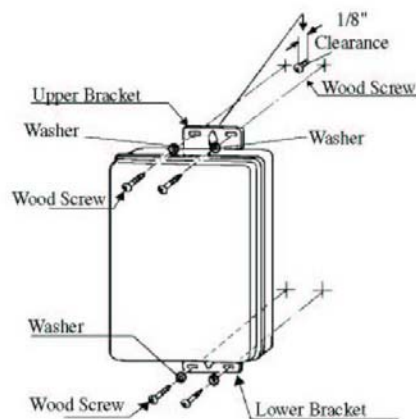

Figure 2

2-2. Electrical Connections

WARNING: Field wiring connections and electrical grounding must comply with local codes, or in the absence of local codes, with the latest edition of the National Electrical Code, ANSI/NFPA 70, or in Canada, Canadian Electrical code, CSA C22.1 Part 1.

POWER CORD (INDOOR Installation Only):

- The electrical power supply requirement for this manifold controller is 120VAC/60Hz, 3 Amps.
- The manifold controller comes with a three (3) pin power supply cord.

- Use only a power outlet with a ground terminal.
- Keep any excess length of the power supply cord on the outside of the manifold controller.
- If local codes require hardwiring of indoor installations or if the manifold controller will be installed outdoors, see instructions below for “Hardwiring the Electrical Connections”.

HARDWIRING THE ELECTRICAL CONNECTIONS (OUTDOOR or INDOOR Installation):

- Wiring should be carried out by a qualified electrician in accordance with local codes.
- The electrical power supply requirement for this manifold controller is 120VAC/60Hz, 3 Amps.
- The manifold controller must be grounded.
- A green screw is provided in the junction box for grounding connection.
- Remove the power supply cord and install the connector for the hardwiring (supplied) to allow hardwiring at the junction box.
- **DO NOT** connect grounding wire to water pipes, gas pipes, telephone cables, lighting conductor circuits and to grounding circuit of other equipment that carry a ground-fault interrupter.
- An ON/OFF switch must be provided and installed for incoming 120VAC power.
- Wire the manifold controller exactly as shown below.
- Connect the live wire to black leg wire and neutral wire to the white neutral wire.

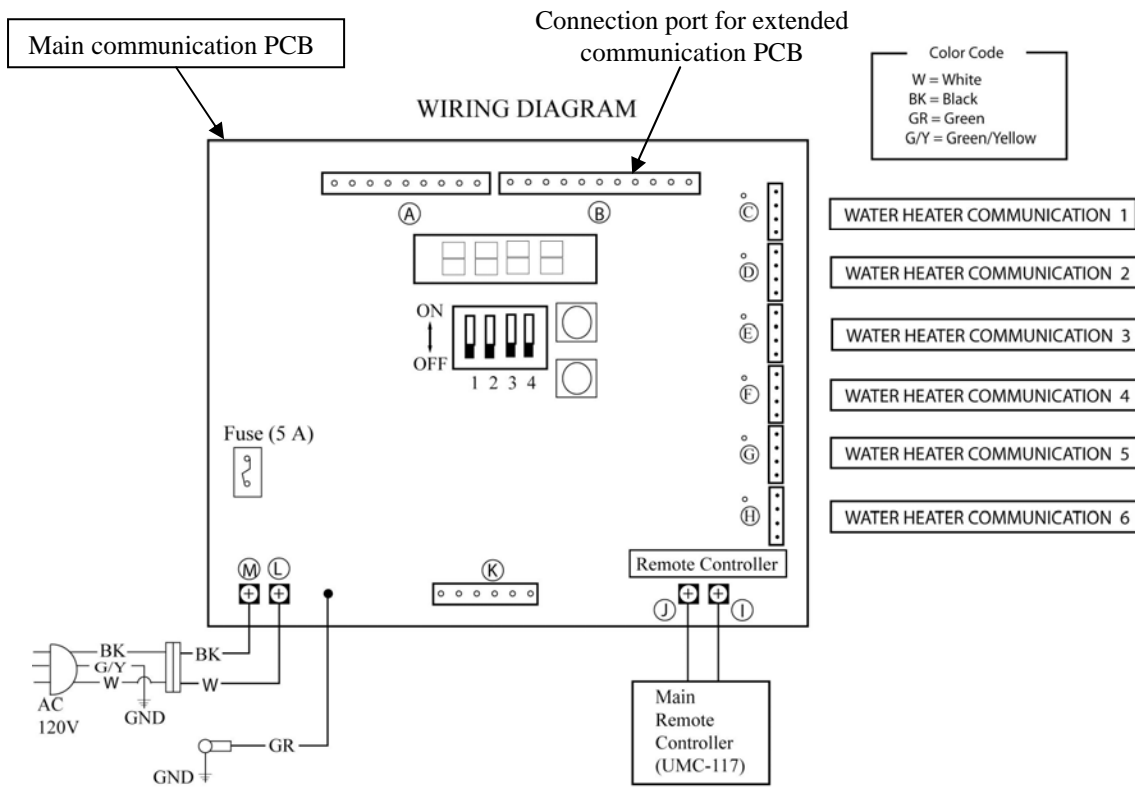

Manifold Controller Wiring diagram

WARNING: Make certain power to the manifold controller and the water heater is “OFF” before removing front cover FOR ANY REASON.

WARNING: Shock hazard line voltage is present. Before servicing MIC-180, turn off the electric power to the MIC-180 at the main disconnect or circuit breaker. Failure to do so could result in severe personal injury or death.

CAUTION: Label all wires prior to disconnection when servicing controls. Wiring errors can cause improper and dangerous operation. Verify correct operation after servicing.

CAUTION: For your safety DO NOT attempt repair of electrical wiring or any controls. Refer repairs to qualified service personnel.

3. Connecting Communication Cable to the Water Heaters and Adjusting the DIP Switch

1. Disconnect power to water heater.
2. Remove the front cover of water heater.

Water heater PCB

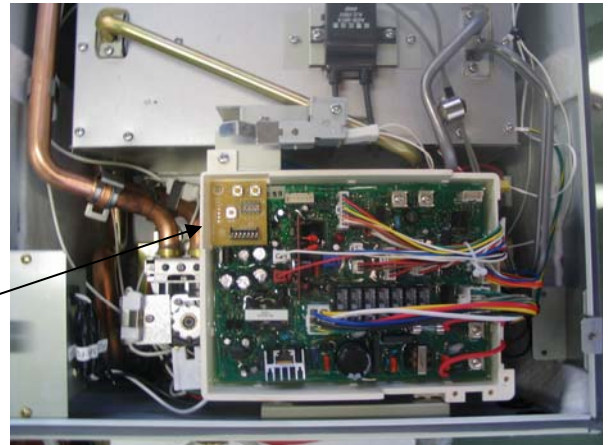

Figure 3

3. Route the communication cable through the hole at the bottom right hand corner of the water heater.
4. Connect the communication cable (MIC-K) to the connector marked "F" in upper right corner of the water heater PCB. See figure 4 for location of connector "F".

Connector "F"

Communication cable to main or extended communication PCB

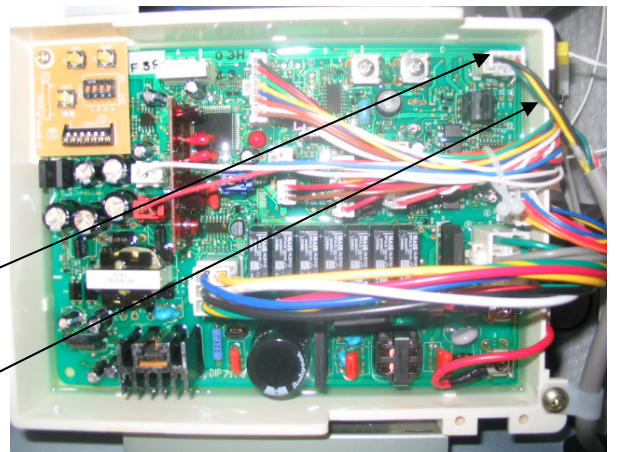

Figure 4

5. Fix communication cable with clamp and one screw as shown in figure 5.

Clamp and screw

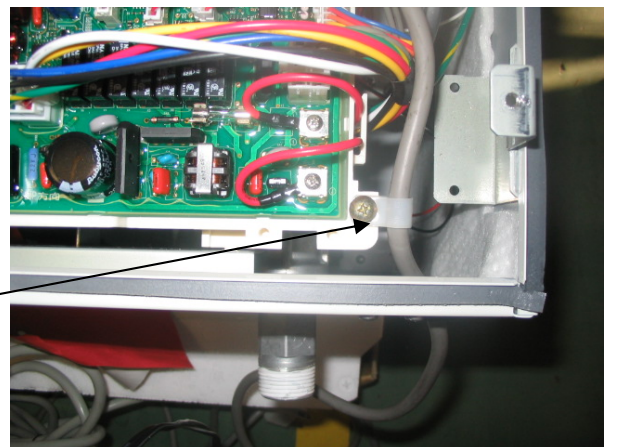

Figure 5

NOTICE: The DIP switch settings on the water heaters must be changed for the water heaters to be controlled by the manifold controller.

6. Change the DIP switch #4 setting on the PCB of the water heater to “ON” position (UP) in order to change the water heater to the manifold installation mode. **DO NOT** alter any other DIP switch. See figure 6 for DIP switch location on water heater PCB.

DIP switch

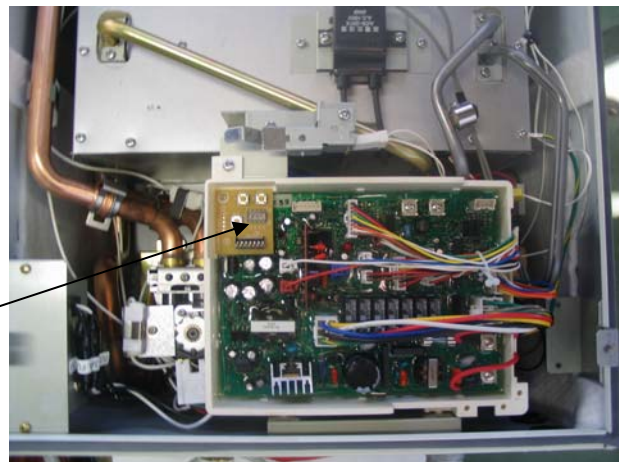

Figure 6

7. Attach front cover of water heater.
8. If required, repeat steps 1 thru 7 to connect the communication cable to each of the water heaters in the manifold system.
9. **DO NOT** turn on the power to the water heaters until all communication cables are connected to the water heaters and the manifold controller.

4. Connecting and Wiring the Manifold Controller

4-1. Connecting and Wiring Main Communication PCB for Controlling Two (2) to Six (6) Water Heaters

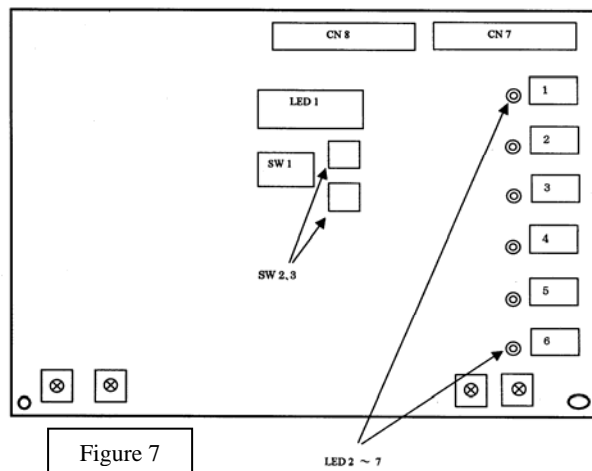

Figure 7

Schematic of main communication PCB

1. Disconnect power to manifold controller.
2. Remove the front cover of manifold controller.
3. Figure 7 shows the schematic drawing of main communication PCB.
4. Figure 8 shows the main communication PCB.
5. Starting with the water heater No. 1 route the communication cable through the opening at the bottom of the manifold controller box as shown in figure 9.

Main communication PCB



Figure 8

6. Connect the communication cable (MIC-K) from the water heater to the connector socket on the right side of the main communication PCB as shown in figure 9.
7. Fix communication cable with a clamp and one screw as shown in figure 9.
8. Pull excess length of the communication cable into the manifold box.
9. If required, repeat steps 1 through 8 to connect the communication cable from each water heater in the manifold system to manifold controller.

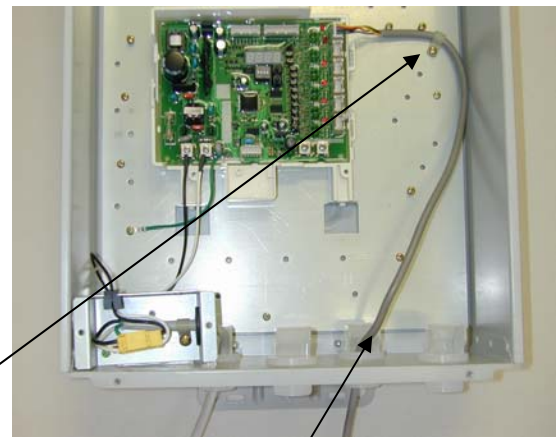

Clamp and screw

Figure 9

Communication cable from water heater No.1

4-2. Connecting Main Remote Control to Manifold Controller

A main remote control (UMC-117) is provided with the water heaters. Install **ONLY ONE** (1) of these main remote controls (UMC-117) to the manifold controller. This remote control will be used to control the temperature of all water heaters in the manifold system.

NOTICE:

Temperature settings can **ONLY** be changed by using the remote control connected to the manifold controller.

The rest of the main remote controls can be used to monitor the operations of each water heater if installed per the water heater instruction manual. Error codes, etc. will be displayed on the remote control, but temperature settings cannot be changed.

The connecting wires can be any Type-T 18 AWG wire similar to a thermostat wire and is not polarity sensitive.

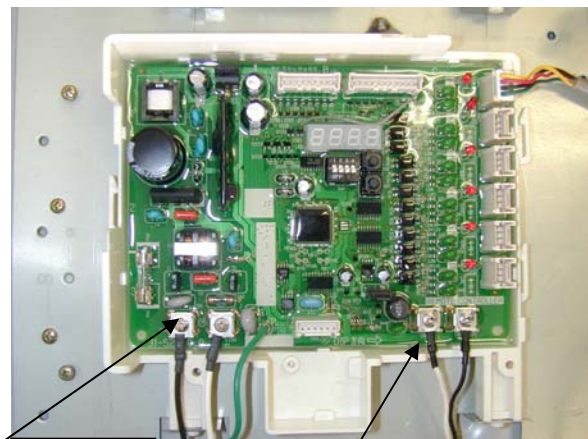

120VAC power terminal

Figure 10

Main remote control terminals

1. Route the wires from the main remote control through the opening at the bottom of the manifold controller box.
2. Connect the wires from the main remote control (UMC-117) to the terminals on the bottom right corner of the main communication PCB as shown in figure 10.

NOTICE:

If water temperatures above 120°F (49°C) are required the DIP switch on main communication PCB needs to be changed. See section 5, “Setting Hot Water Temperature” on page 9 for instructions.

An extended communication PCB (sold separately) is required if more than six (6) water heaters are installed in a manifold system. See section 6, “Typical Installation of Extended Manifold Controller” on page 10 for installation instructions of the extended communication PCB.

3. Attach the front cover of manifold controller once all cables and wires are attached to the main communication PCB.
4. Turn power on to the system after all cables and wires are attached, and adjustments are completed.

5. Setting Hot Water Temperature

WARNING: Refer to the safety warnings in this instruction sheet and the water heater instruction manual before setting the hot water temperature. Temperature can only be set or changed with the main remote control (UMC-117) wired to the manifold controller.

NOTICE: DIP switch changes to adjust temperature are made on the manifold controller only.

Refer to the water heater instruction manual for setting hot water temperature. The default temperature range of the main remote control is 100°F to 120°F (38°C to 49°C). It is possible to change the range up to 180°F (82°C) by making the following adjustments.

Required adjustment for achieving 180°F (82°C) maximum water temperature setting (See figure 11 for DIP switch and button locations)

1. Turn off the remote controls. Turn off gas and water supply to all water heaters in the manifold system.
2. Remove the front cover of the **manifold controller (MIC-180)**.
3. Find the DIP switch located below the LED display.
4. Change the DIP switch #4 setting on the main communication PCB to the "ON" position (UP). **DO NOT** alter any other DIP switch.

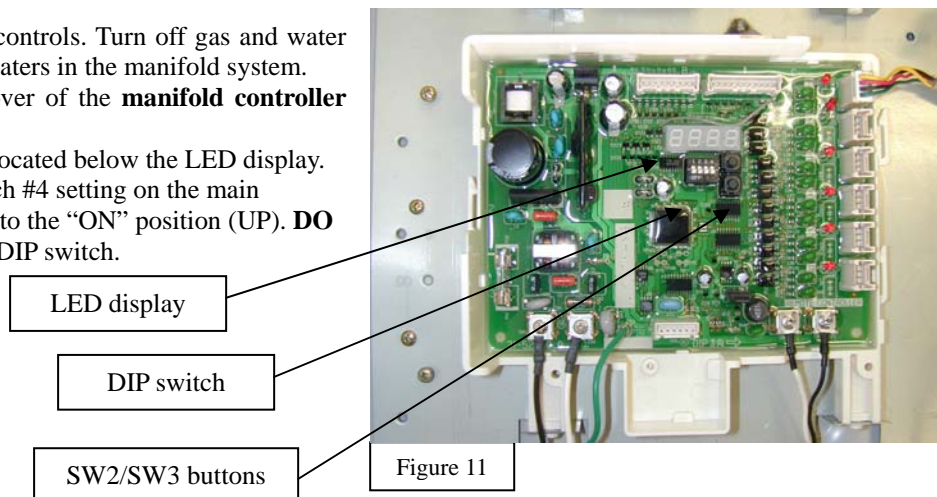

5. Press the SW2 button located below the LED display (See figure 11 for location of the button). The LED display on the PCB displays "ON".
6. When the LED displays "ON", release the SW2 button.
7. Change the DIP switch #4 setting back to the "OFF" position (DOWN). **DO NOT** alter any other DIP switch.
8. Attach the front cover of the manifold controller.
9. Turn on the remote control.
10. Restore gas and water supply for all water heaters in the manifold system.
11. Check and ensure safe operation and performance of water heaters.
12. See steps below to change the maximum temperature setting back to 120°F (49°C).

Required adjustment for changing setting back to 120°F (49°C) maximum water temperature setting (See figure 11 for DIP switch and button locations)

1. Turn off the remote controls. Turn off gas and water supply to all water heaters in the manifold system.
2. Remove the front cover of the **manifold controller (MIC-180)**.
3. Find the DIP switch located below the LED display.
4. Change the DIP switch #4 setting on the main communication PCB to the "ON" position (UP) (See figure 11 for location of DIP switch). **DO NOT** alter any other DIP switch.
5. Press the SW3 button. The LED display on the PCB displays "OFF".
6. When the LED displays "OFF", release the SW3 button.
7. Change the DIP switch #4 setting back to the "OFF" position (DOWN). **DO NOT** alter any other DIP switch.
8. Attach the front cover of the manifold controller.
9. Turn on the remote control.
10. Restore gas and water supply for all water heaters in the manifold system.
11. Check and ensure safe operation and performance of water heaters.

6. Typical Installation of Extended Manifold Controller For Manifolding seven (7) to twenty (20) Water Heaters

Manifold controller (MIC-180) provides control of two (2) to six (6) water heaters when properly installed and connected with communication cables (sold separately) to any Rheem-Ruud or Paloma commercial Tankless Water Heaters. To control additional water heaters (7 to 20 water heaters), it is necessary to purchase separately and install an extended communication PCB (MICS-180) in the control system.

Example of typical installation using both main communication PCB and extended communication PCB (MICS-180) is shown below in figure 12.

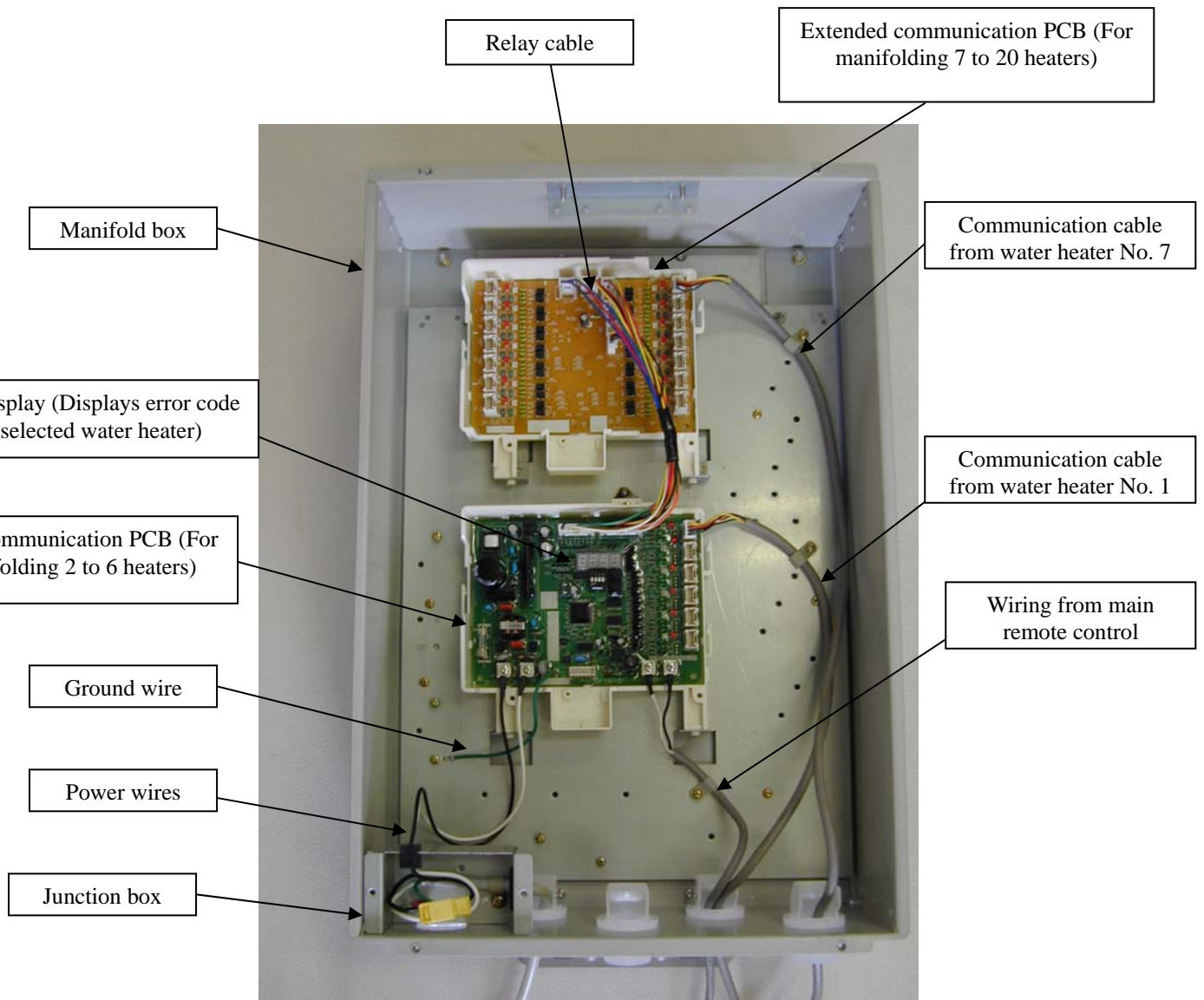

Figure 12

6-1. Connecting and Wiring the Extended Manifold Controller

1. Follow the instructions in sections 1-4 for installing the water heaters and main manifold controller.
2. Disconnect power to the manifold controller.
3. Remove the front cover of manifold controller.
4. Install the extended communication PCB (MICS-180) with one screw to the manifold box directly above the main communication PCB as shown in figure 13.

Extended communication PCB



Figure 13

5. Route the communications cable up through the opening at the bottom of the manifold controller.
6. Connect the communication cable (MIC-K) from water heaters 7 through 20 to the connectors on the right or left side of the extended communication PCB (MICS-180) as shown in Figure 14.
7. Fix each communication cable with a clamp and one screw as shown in figure 14.
8. Pull excess communication cable into the manifold box.

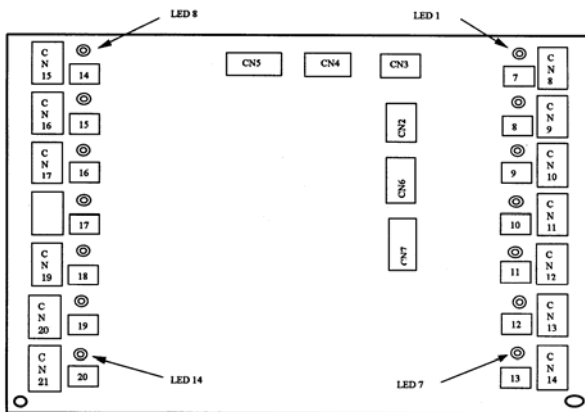

Schematic of extended communication PCB

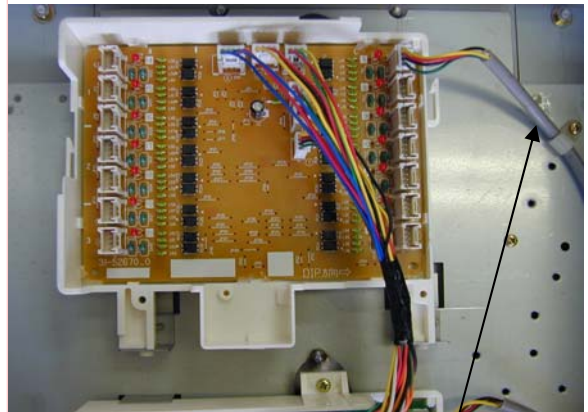

Figure 14

Communication cable from water heater No. 7

9. Connect the relay cable between main communication PCB and extended communication PCB as shown in figure 14.
10. Figure 15 to the right shows the water heater PCB with the communication cable connected.
11. Attach front cover of manifold controller.
12. Turn the power on to the manifold controller and the water heaters, once all communication cables from the water heaters are connected to the extended communication PCB.

Water heater PCB

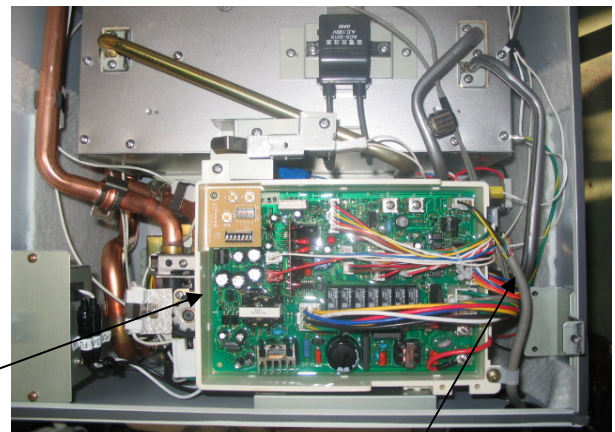
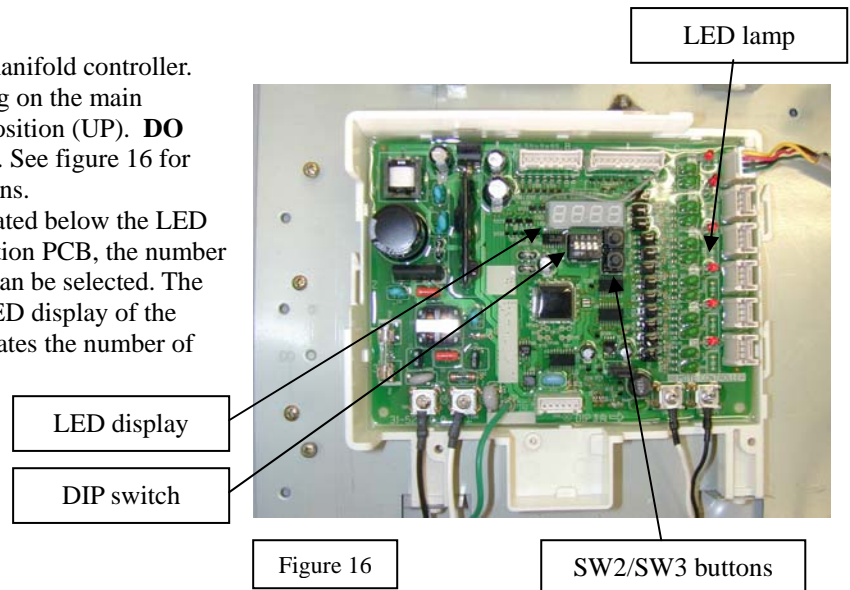

Figure 15

Communication cable from manifold controller

7. Trial Operation of Manifold Installation Controller (MIC-180) and Water Heaters

1. Remove the front cover of the manifold controller.
2. Change the DIP switch #1 setting on the main communication PCB to “ON” position (UP). **DO NOT** alter any other DIP switch. See figure 16 for location of DIP switch and buttons.
3. By pressing the SW2 button located below the LED display on the main communication PCB, the number of the water heater to be tested can be selected. The left two digits flashing on the LED display of the main communication PCB indicates the number of the water that has been selected.



4. Press the SW3 button on the main communication PCB to change to trial operation mode. The left two digits of the LED display will indicate the water heater selected and will illuminate continuously. At the same time, the LED lamp on the main communication PCB or the extended communication PCB corresponding to the water heater selected will illuminate and indicate the water heater is in trial operation mode.
5. Open the hot water outlet. Check and ensure safe operation and performance of the water heater selected.
6. Change the DIP switch #1 setting to the “OFF” position (DOWN) to end the trial operation mode.
7. To choose different water heater for trial operation repeat steps 3 through 6.

8. IF YOU NEED SERVICE

1. Refer to these instructions and the instruction manual that came with the water heater for additional information.
2. Should you have any questions about your new water heater or manifold controller, or if these require adjustment, repair, or routine maintenance, it is suggested that you first contact your installer, plumbing contractor or previously agreed upon service agency. In the event the firm has moved, or is unavailable, refer to the telephone directory, commercial listings or local utility for qualified service assistance.
3. Should your problem not be solved to your complete satisfaction, you should then contact the Manufacturer’s National Service Department. Refer to the section titled “IF YOU NEED SERVICE” in the Use and Care Manual provided with your water heater(s) for contact information and procedures.